

Table of Contents

GLS ----- 2
General lighting, remote driver

DLS -----17
Decorative lighting, remote driver

PLS ----- 37
Pro lighting, integrated driver

LED STRIP -----49
Low voltage LED strip, white, RGB, RGBW

LED DRIVER -----65
NON-Dimmable driver, Triac dimmable



GLS

General lighting system

Powerful lighting, flexible installation and customizable size to provide enough lights and match the different scenario in residential and commercial place.





Rectangle Fixture



LS3535

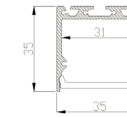

Working Voltage	POWER	LUMEN
24V	8 W/FT	838 LM/FT

LS5050

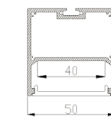

Working Voltage	POWER	LUMEN
24V	8.8 W/FT	915 LM/FT

LS7477

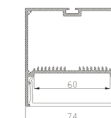

Working Voltage	POWER	LUMEN
24V	11 W/FT	1158 LM/FT

Model	Finish	Size	CCT	Installation	Driver
LS3535	SV: Silver	___Inch	27: 2700K	SS: Suspension	ND: Non-dimmable
LS5050	BK: Black	___MM	30: 3000K	SF: Surface	TD: Traic dimmable
LS7477	WH: White	___MM	40: 4000K	RE: Recessed	VD: 0-10V dimmable





Recessed Fixture

LE4932

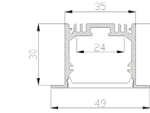

Working Voltage	POWER	LUMEN
24V	8 W/FT	838 LM/FT

LE6332

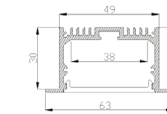

Working Voltage	POWER	LUMEN
24V	8.8 W/FT	915 LM/FT

LE8832

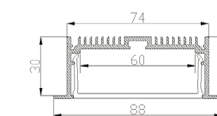

Working Voltage	POWER	LUMEN
24V	11 W/FT	1158 LM/FT

Model	Finish	Size	CCT	Installation	Driver
LE4932	SV: Silver	___Inch	27: 2700K	RE: Recessed	ND: Non-dimmable
LE6332	BK: Black	___MM	30: 3000K		TD: Traic dimmable
LE8832	WH: White		40: 4000K		VD: 0-10V dimmable







Tube Fixture



LT40

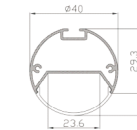

Working Voltage	POWER	LUMEN
24V	6 W/FT	640 LM/FT

LT60

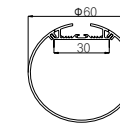

Working Voltage	POWER	LUMEN
24V	8 W/FT	838 LM/FT

LT120

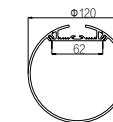

Working Voltage	POWER	LUMEN
24V	11 W/FT	1158 LM/FT

Model	Finish	Size	CCT	Installation	Driver
LT40	SV: Silver	40mm	27: 2700K	SS: Suspension	ND: Non-dimmable
LT60	BK: Black	60mm	30: 3000K		TD: Traic dimmable
LT120	WH: White	120mm	40: 4000K		VD: 0-10V dimmable

The background of the slide features a dark, almost black, space with several thin, vertical white lines extending from the top to the bottom. At the end of each line, there is a soft, glowing white light that creates a subtle, circular glow on the dark background. There are four such light sources visible, positioned at the top and bottom of the frame, creating a symmetrical, minimalist aesthetic.

DLS

Decorative lighting system

Widely used in a variety of interior decoration scenes and partial lighting space. Base on the general lighting, some auxiliary lighting is used to decorate the environment, giving the environment a different visual enjoyment.



Ceiling & Wall

Recessed on the wall or ceiling to create a stylish and creative space with decorative lighting effects.



Vanity & Cabinet

Install on the back of vanity or under the cabinet to achieve the role of auxiliary lighting and atmosphere creation.



Closet & Shelf

Easy and convenient installation in closet, shelf and other furniture systems to meet the needs of portion space lighting.



Showcase & Display

Widely used in the showcase and display of commercial store, the color and vitality of the products are displayed to the fullest.

Zero Spot

Only perfect and uniform lighting effect



Two Outlets

Two end caps, screwless design

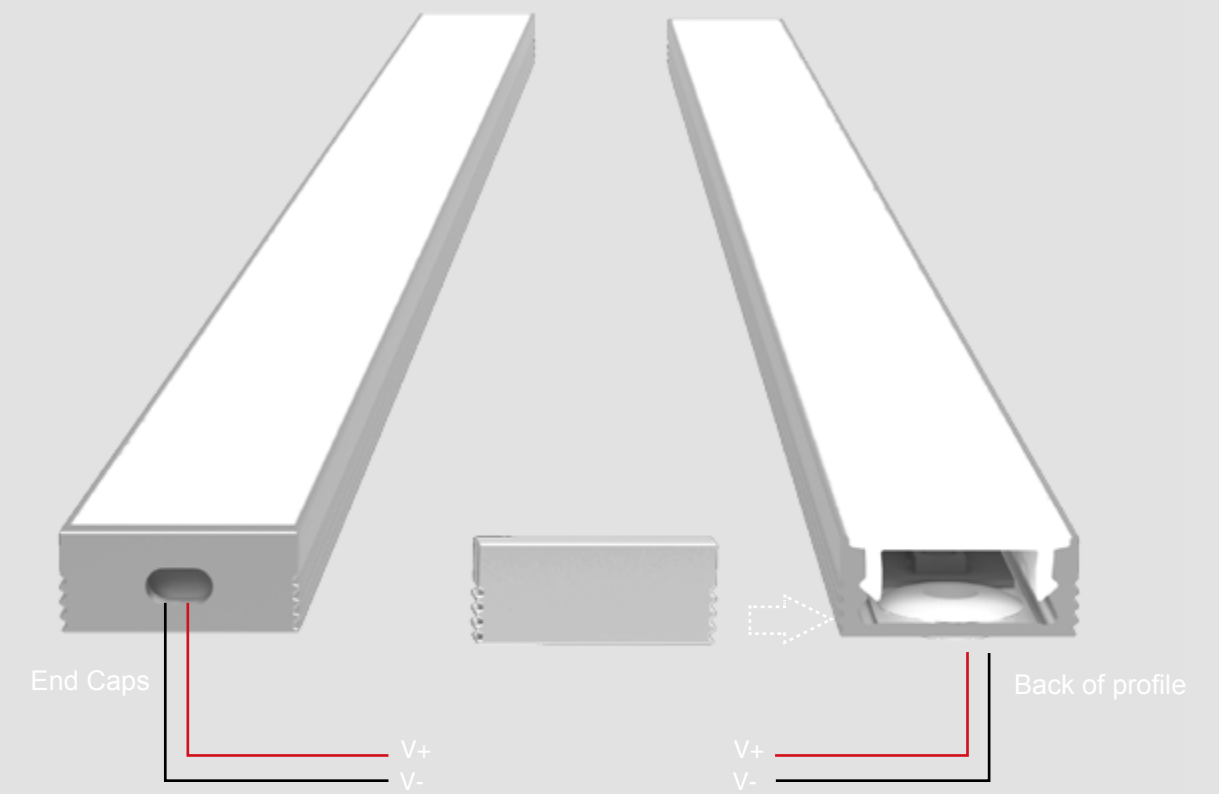



LS1911C

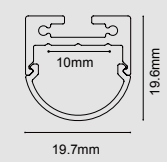
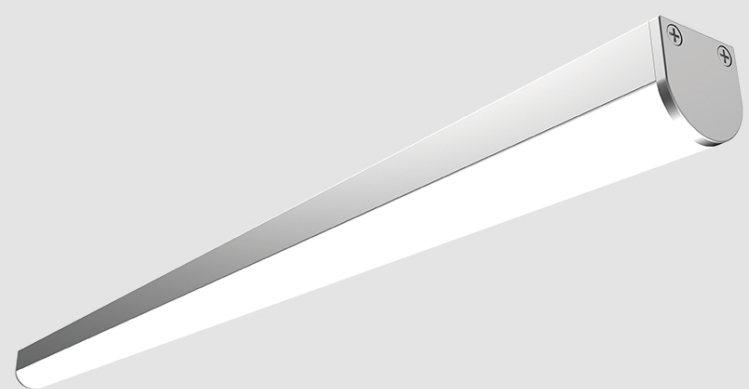

LS1911K

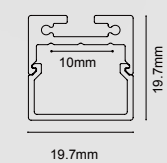

LS1911P

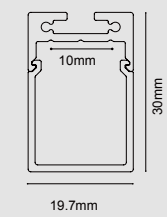

Working Voltage	POWER	LUMEN
24V	6 W/FT	640 LM/FT

Model	Finish	Size	CCT	Installation	Driver
SV: Silver	___Inch	27: 2700K	SF: Surface	ND: Non-dimmable	
	___MM	30: 3000K	SS: Suspension	TD: Traic dimmable	
		40: 4000K		VD: 0-10V dimmable	



LS1607

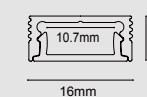
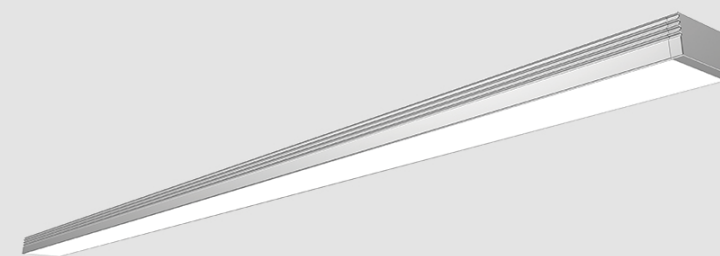

Working Voltage	POWER	LUMEN
24V	3 W/FT	442 LM/FT

LE2507

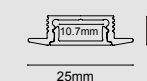
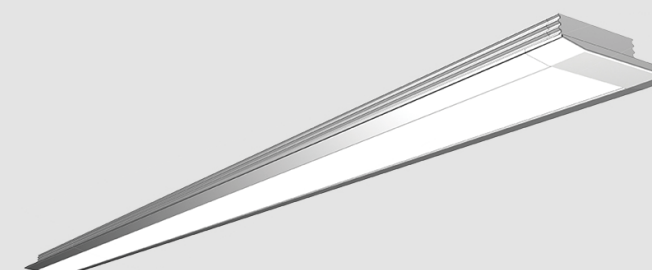

Model	Finish	Size	CCT	Installation	Driver
SV: Silver	___Inch ___MM	27: 2700K	SF: Surface	ND: Non-dimmable	
		30: 3000K	RE: Recessed	TD: Traic dimmable	
		40: 4000K		VD: 0-10V dimmable	



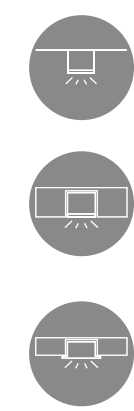

LS1613

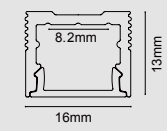
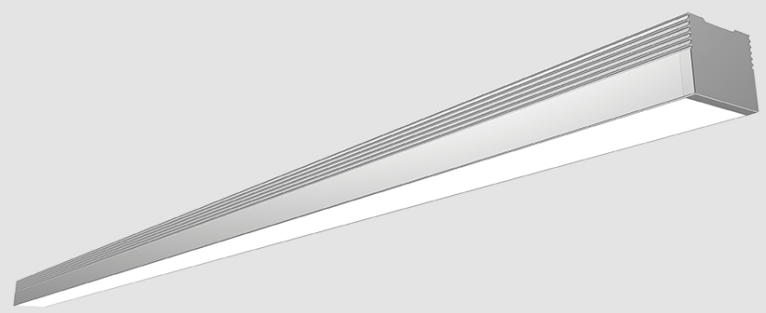

Working Voltage	POWER	LUMEN
24V	3 W/FT	323 LM/FT

LE2513

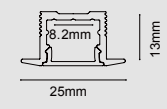
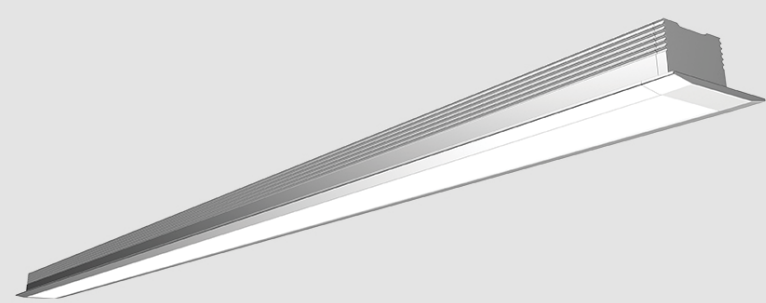

Model	Finish	Size	CCT	Installation	Driver
SV: Silver	___Inch ___MM	27: 2700K	SF: Surface RE: Recessed	ND: Non-dimmable TD: Traic dimmable VD: 0-10V dimmable	
		30: 3000K			
		40: 4000K			



LS0709

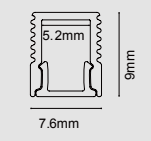
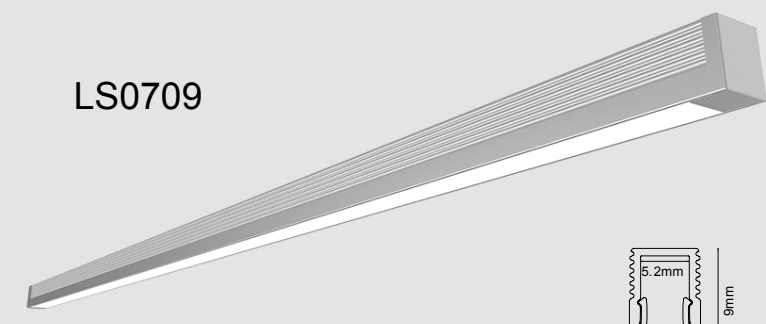

Working Voltage	POWER	LUMEN
24V	3 W/FT	200 LM/FT

Model	Finish	Size	CCT	Installation	Driver
	SV: Silver	___Inch	27: 2700K	SF: Surface	ND: Non-dimmable
		___MM	30: 3000K		TD: Traic dimmable
			40: 4000K		VD: 0-10V dimmable



LG1616C

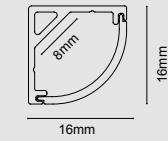
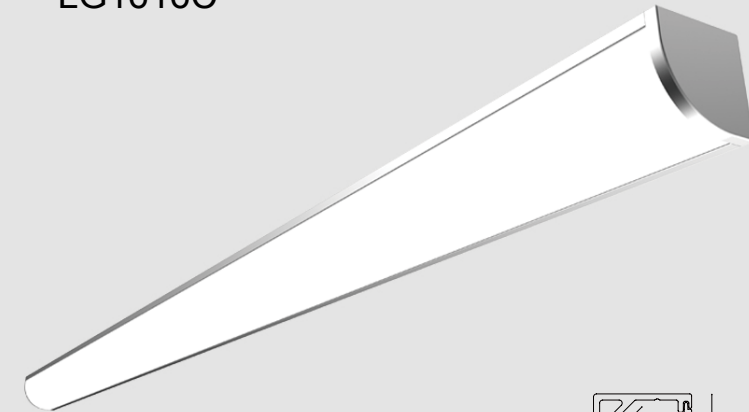

Working Voltage	POWER	LUMEN
24V	4.4 W/FT	399 LM/FT

LG1616K

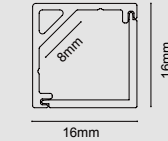
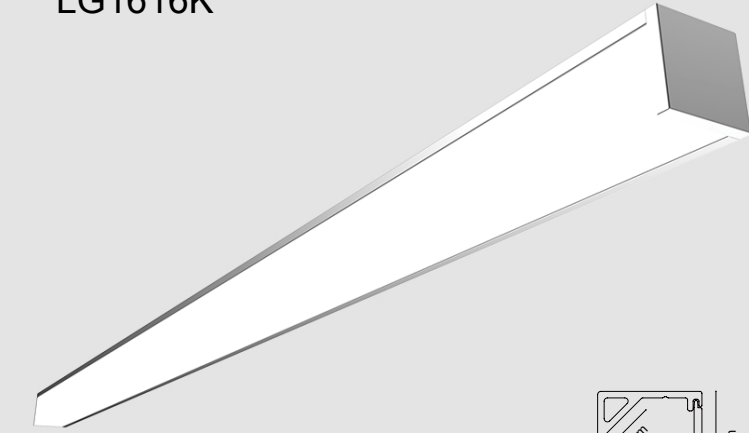

Model	Finish	Size	CCT	Installation	Driver
SV: Silver	___Inch	27: 2700K	SF: Surface	ND: Non-dimmable	
	___MM	30: 3000K		TD: Traic dimmable	
		40: 4000K		VD: 0-10V dimmable	



LG3030C

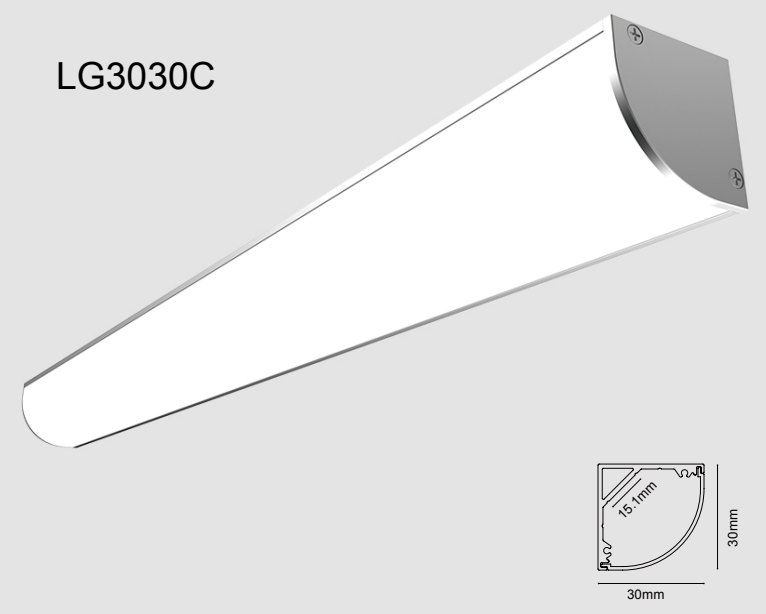

LG3030K

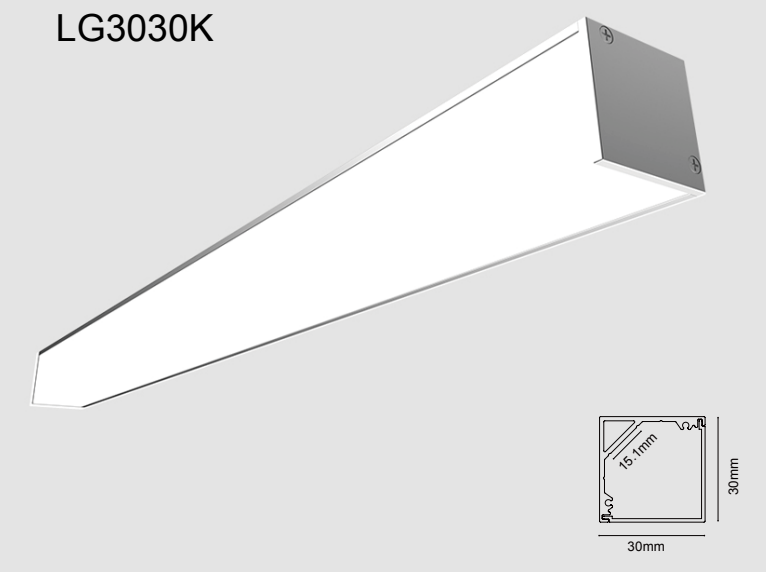

Working Voltage	POWER	LUMEN
24V	6 W/FT	640 LM/FT

Model	Finish	Size	CCT	Installation	Driver
SV: Silver	—	— Inch	27: 2700K	SF: Surface	ND: Non-dimmable
		— MM	30: 3000K		TD: Traic dimmable
			40: 4000K		VD: 0-10V dimmable



PLS

Professional lighting system

Integrate driver, extendable system and powerful lighting to provide the convenience during the lighting design, installation and daily usage.

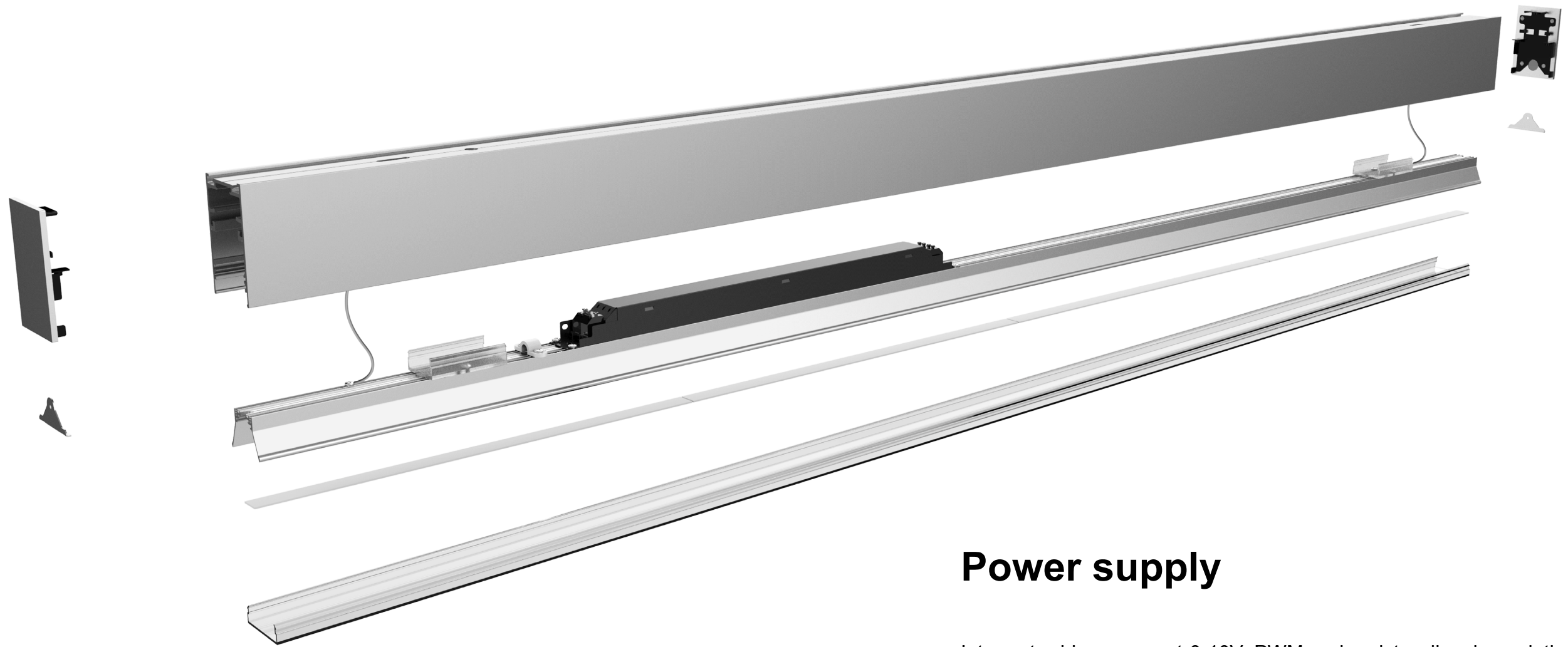

Power supply

Intergrate driver, support 0-10V, PWM and resistor dimming solution, adopt UL Class P certified power supply.



Extension

Special design connector, strong and durable.

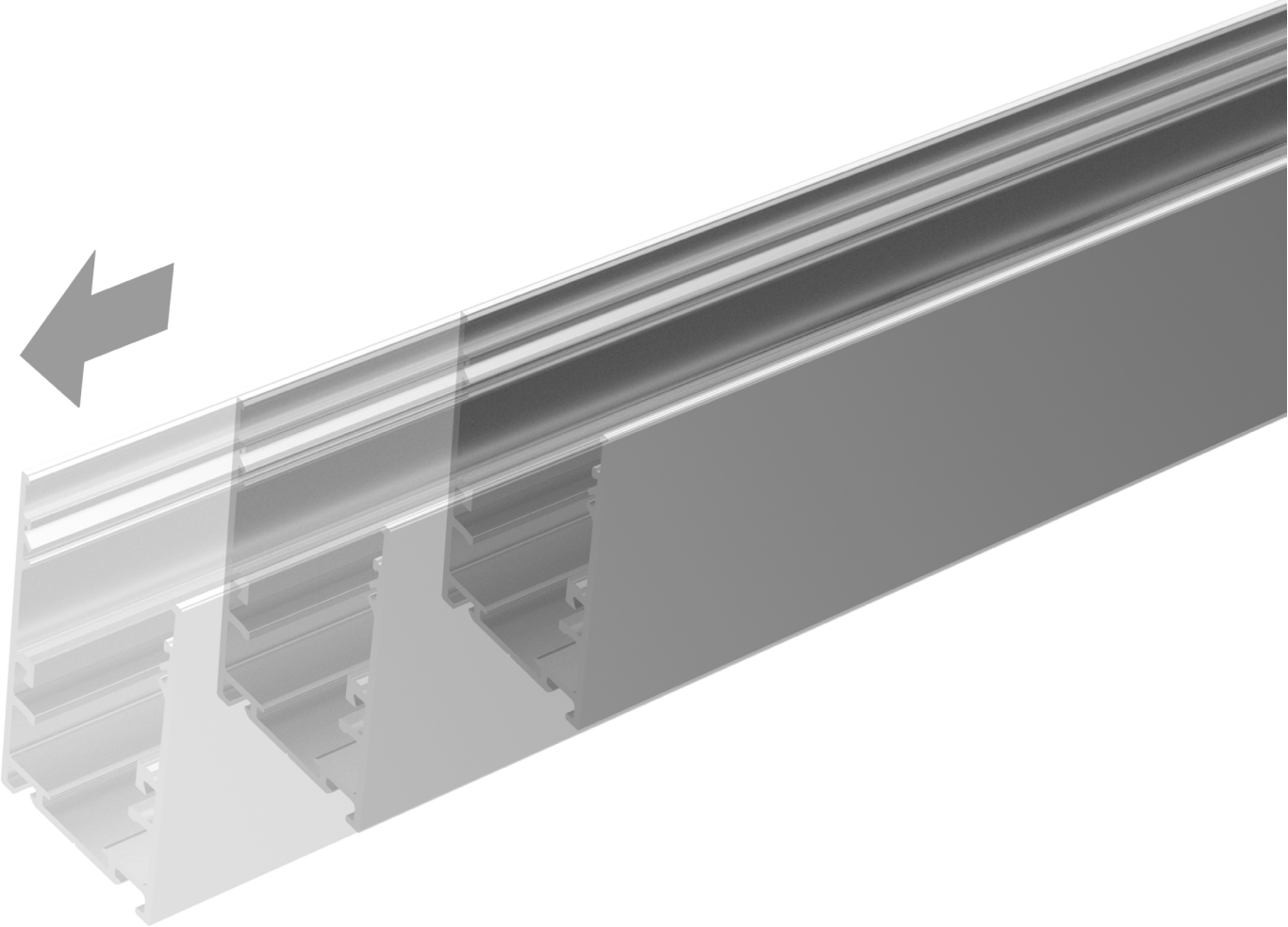
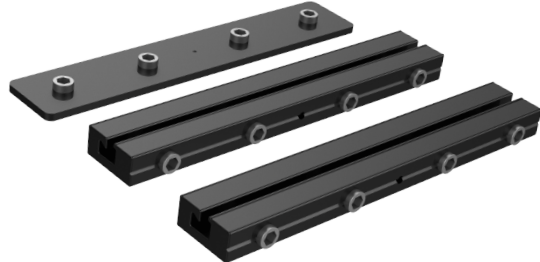

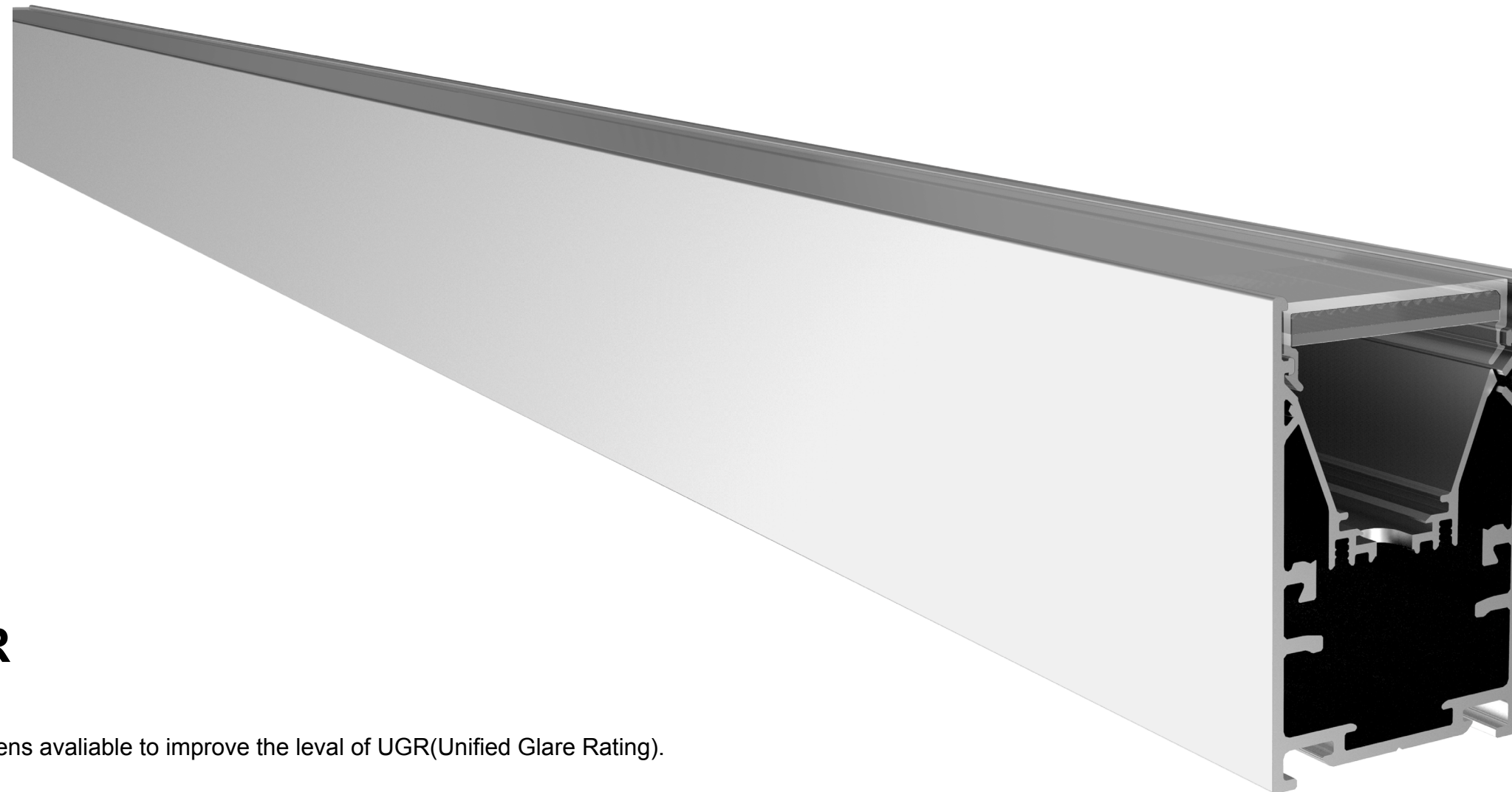

UGR

Special lens available to improve the level of UGR(Unified Glare Rating).

UGR Rating	Environment
UGR ≤ 16	Technical drawing
UGR ≤ 19	Reading, writing, training, meetings, computer-based work
UGR ≤ 22	Craft and light industries
UGR ≤ 25	Heavy industry
UGR ≤ 28	Railway platforms, foyers



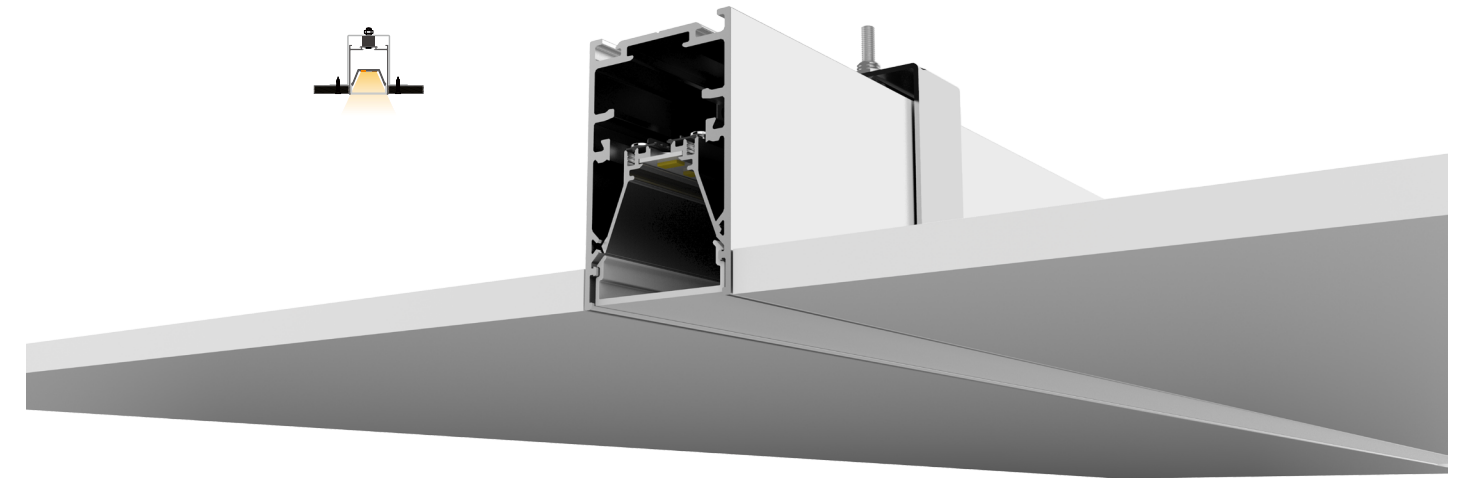
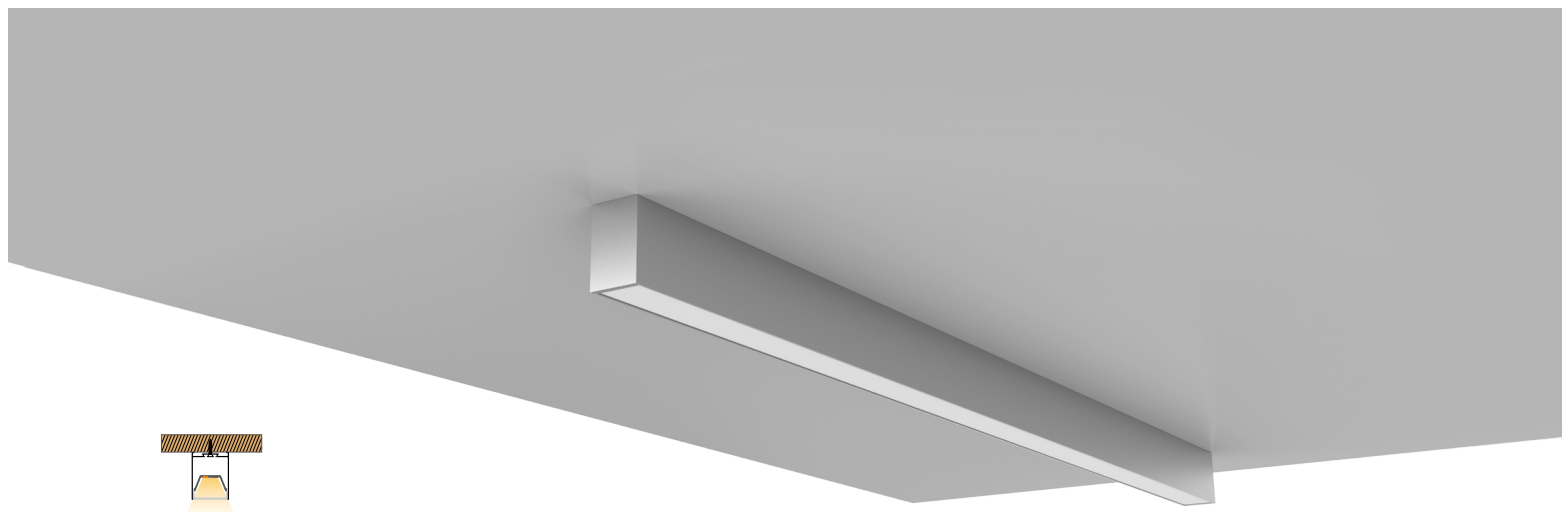

APPLICATION

4 kinds of installation methods almost cover all of the application for an linear lighting project.

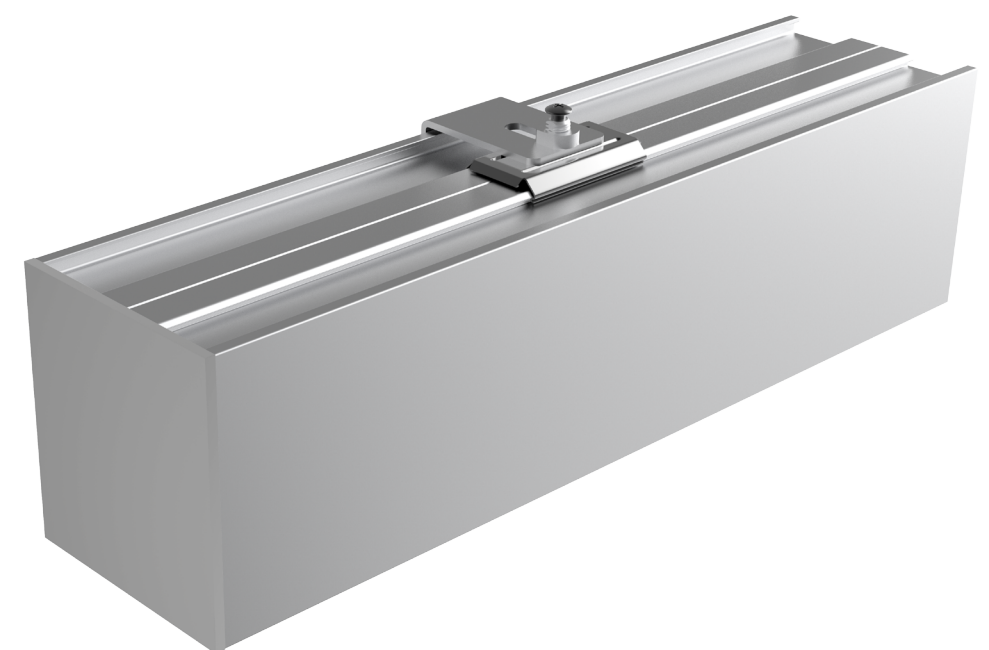

Direct lights

LS5570

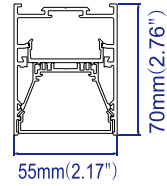
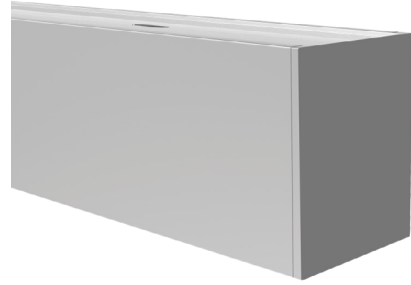
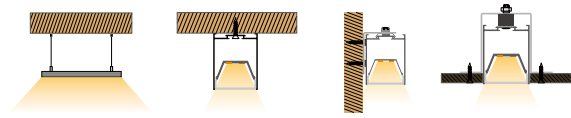

Working Voltage	POWER	LUMEN
100-277 VAC	7.8W/FT	775LM/FT

LS9086

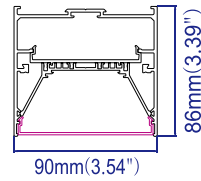
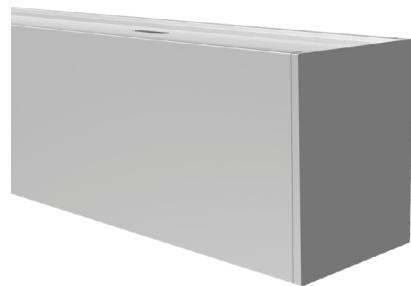

Working Voltage	POWER	LUMEN
100-277 VAC	11.3W/FT	1250LM/FT

Direct & Indirect lights

LS5580D

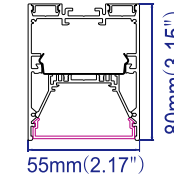
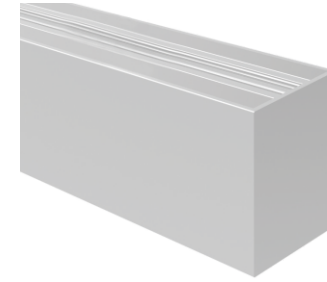
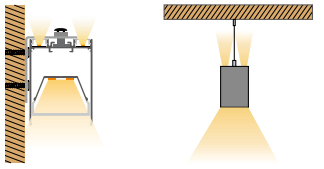

Working Voltage	POWER	LUMEN
100-277 VAC	UP: 5.5W/FT DOWN: 5.5 W/FT	UP: 556 LM/FT DOWN: 556 LM/FT

Model	Finish	Size	CCT	Installation
	SV: Silver	4 FT	30: 3000K	SS: Suspension
	BK: Black	8 FT	40: 4000K	SF: Surface
	WH: White	__ FT*		RE: Recessed
				WL: Wall mount

*Only come with any size combine by 4FT and 8FT.



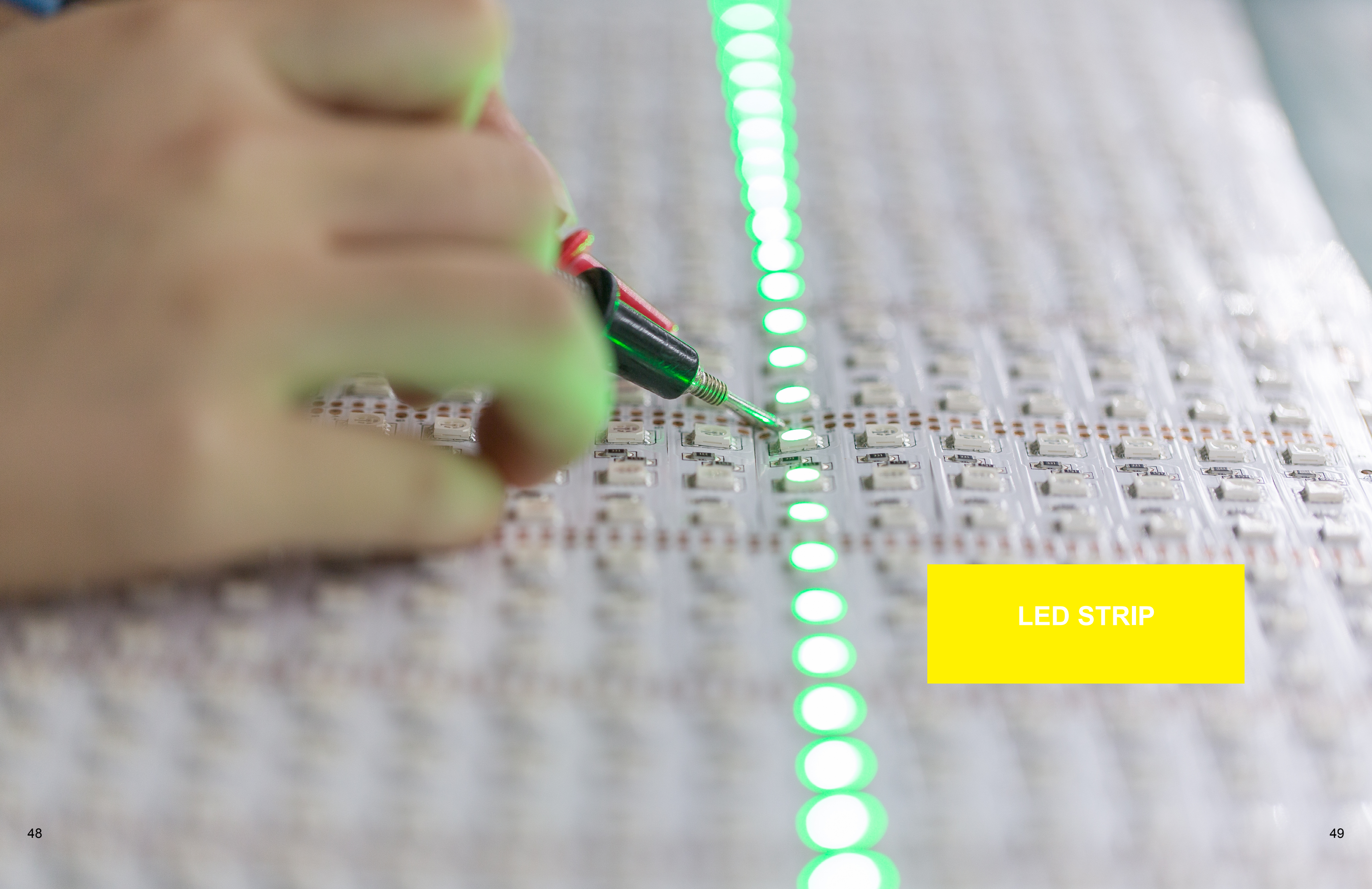

LED STRIP

ICON DESCRIPTION
Description des symboles



CCT



Color



Lumen/m



Voltage



Power



IP Grade



LED QTY/M



Minimal cut



Dimensions

WATERPROOF GRADE
Qualité d'anti-l'eau

Gel Coating
Couverture de Gel **IP55**

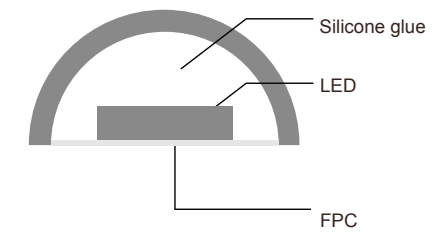

Glue filling
remplissage de colle **IP67**

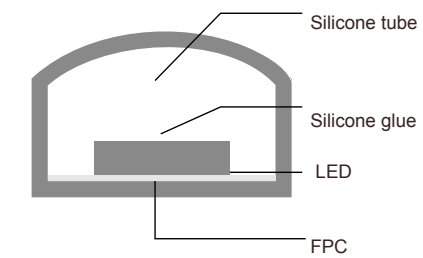

ANTI-UV 3 YEARS
LOW TEMPERATURE -30°

Correlated COLOR TEMPERATURE(CCT) TEMPÉRATURE DE COULEUR

Higher CCT is close to bluish, and lower CCT is close to yellowish, JOYOLIGHT offers 4 CCT options for different lighting effects.
6000K with the feeling of neutral and bright, suits the office lighting,
4000K with the feeling of comfort and mildness, suits the residential lighting,
3000K with the feeling of warm and safety, suits the personal space lighting,
2700K with the golden visual effects, suits the special occasions.

CCT élevée cause une couleur blanc bleuâtre et, CCT faible cause une couleur blanc jaunâtre.
JOYOLIGHT vous propose quatre choix de CCT, pour des différents effets d'éclairage.
6000K donne un sentiment neutre et clair, conseille pour l'éclairage de bureau,
4000K donne un sentiment de confort et une douceur, conseille pour l'éclairage résidentiel,
3000K donne un sentiment de la chaleur et sécuritaire, conseille pour l'éclairage de l'espace personnel,
2700K donne un sentiment d'élégance et luxueux, conseille pour des occasions intimes et particulières.



Color Rendering Index(CRI) Indice de Rendu des Couleurs

The CRI is higher, and the color is more natural.
Full range of JOYOLIGHT LED are with CRI > 80, presenting the true color for you.

Le CRI est plus CRI est élevé, plus la couleur est paraît naturelle.
Une gamme complète de JOYOLIGHT DEL est avec CRI > 80, représentée la vraie couleur pour vous.



D 3 60 - XX - IPXX

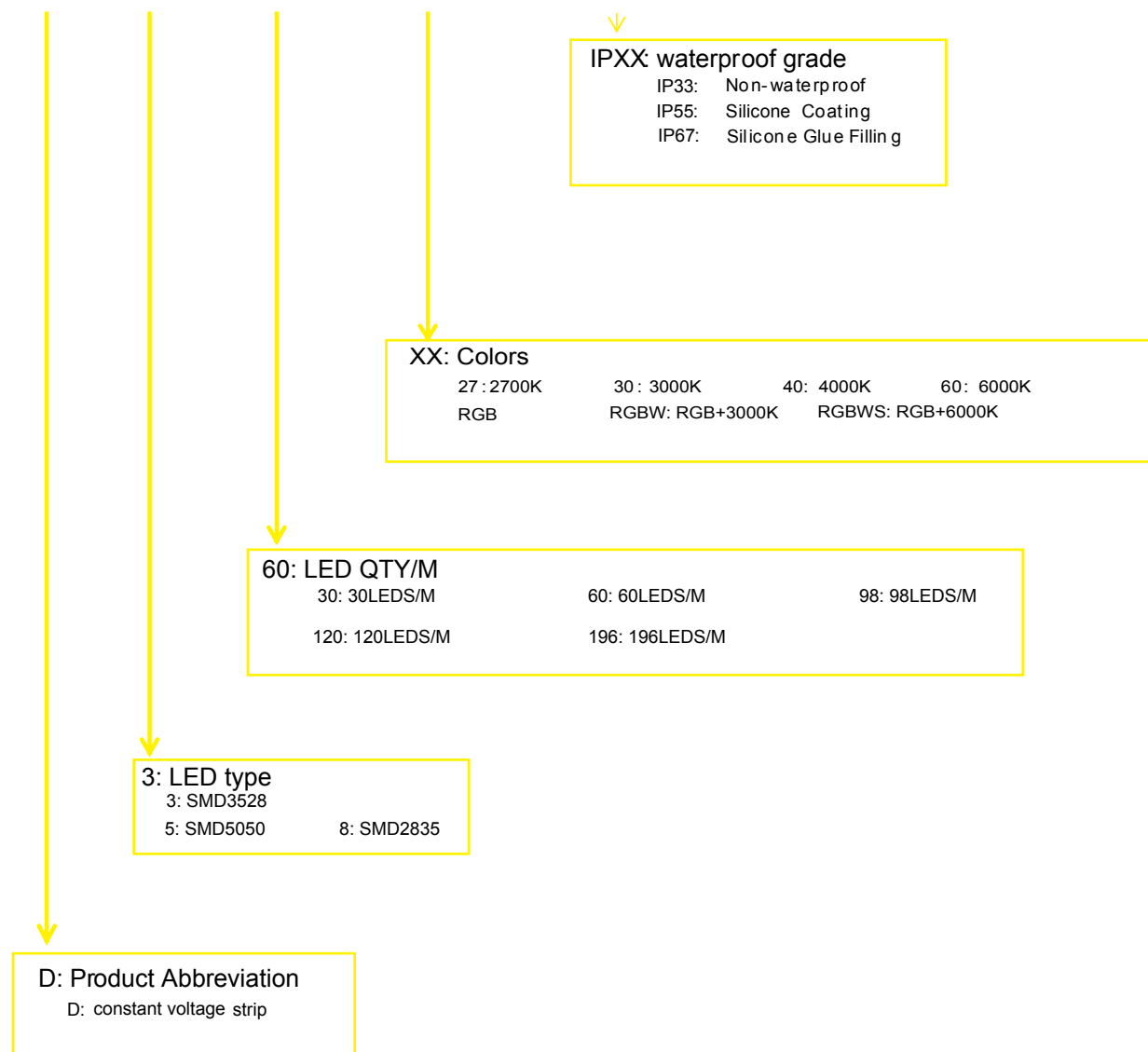

D3 SERIES



D360



D3120

D5 SERIES



D560RGB



D560RGBW

D8 SERIES



D860



D898



D8120



D8196



3528 series is cost effective, suitable for supplementary and background lighting.

3528 série est rentable , adapté à l'éclairage de fond et supplémentaire

D3 Series



D360

2700K/3000K/4000K/6000K



360 LM/m
110 LM/ft

24V

4.8 W/m
1.5 W/ft

IP33 / IP55 / IP67

60LED/m

100mm(6LED)

5000*8*2mm

D3120

2700K/3000K/4000K/6000K



655 LM/m
200 LM/ft

24V

9.6 W/m
3.0 W/ft

IP33 / IP55 / IP67

120LED/m

50mm(6LED)

5000*8*2mm

**Not in stock, special order only.*

D5 Series



RGB LEDs work with controller to create different color effects.
 RGBWS strip could provide high quality white and RGB lighting, free to change the space atmosphere.

DEL RGB varie ses différents effets de couleur avec un contrôleur infra-rouge.
 RGBWS rubans blanche pourrait donner une éclairage RVB de qualité superbe. Une grande liberté pour le changement d'atmosphère pour l'espace.



D560RGB

D560RGBW



/

RGB+3000K / RGB+6000K



24V

24V



14.4 W/m
4.4 W/ft

19.2 W/m
5.9 W/ft



IP33 / IP55 / IP67

IP33 / IP55 / IP67



60LED/m

60LED/m



100mm(6LED)

100mm(6LED)



5000*10*2mm

5000*12*2mm

D8 Series



2835 series, brightness of single LED is higher than 10 LM, luminous efficacy is about 100 LM/w, those items are widely used for main lighting and auxiliary lighting of indoor.

2835 série , luminosité de LED unique est supérieure à 10 LM , efficacité lumineuse est d'environ 100 lm / W , ces éléments sont largement utilisés pour l'éclairage principal et un éclairage auxiliaire de l'intérieur



D860

2700K/3000K/4000K
6000K

660 LM/m
201 LM/ft

24V

7.2 W/M
2.2 W/ft

IP33

60LED/M

50MM(3LED)

5000×8×1.5MM

D898

2700K/3000K/4000K
6000K

1060 LM/m
323 LM/ft

24V

10 W/M
3 W/ft

IP33

98LED/M

71MM(7LED)

5000×8×1.5MM

D8120

2700K/3000K/4000K
6000K

1310 LM/m
399 LM/ft

24V

14.4 W/M
4.4 W/ft

IP33

252LED/M

50MM(6LED)

5000×8×1.5MM

D8196

2700K/3000K/4000K
6000K

2100 LM/m
640 LM/ft

24V

20 W/M
6 W/ft

IP33

196LED/M

71MM(14LED)

5000×15×2MM

LED STRIP ACCESSORRIES

WHITE LIGHTS

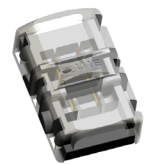

LL2P-IP33

LED strip extension connector, for IP33 LED strip

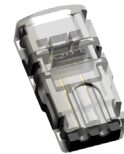

LC2P-IP33

LED strip cable connector, for IP33 LED strip

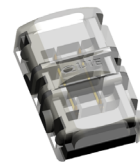

LL2P-IP55

LED strip extension connector, for IP55 LED strip

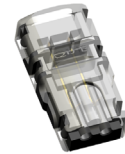

LC2P-IP55

LED strip cable connector, for IP55 LED strip



C2P-20

2 pin cable Ag20



CC4P

2 pin cable connector



CC6P

2 pin cable T connector

RGB LIGHTS

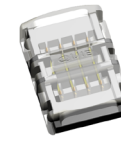

LL4P-IP33

LED strip extension connector, for IP33 LED strip

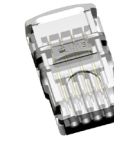

LC4P-IP33

LED strip cable connector, for IP33 LED strip

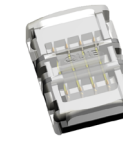

LL4P-IP55

LED strip extension connector, for IP55 LED strip



LC4P-IP55

LED strip cable connector, for IP55 LED strip



C4P-20

4 pin cable Ag20



CC6P

2 pin cable T connector



RE-RGB



CON-LED

RGBW LIGHTS

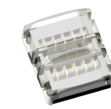

LL4P-IP33

LED strip extension connector, for IP33 LED strip



LC4P-IP33

LED strip cable connector, for IP33 LED strip

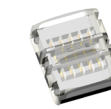

LL4P-IP55

LED strip extension connector, for IP55 LED strip



LC4P-IP55

LED strip cable connector, for IP55 LED strip



C5P-20

5 pin cable Ag20



CC3P

1 pin Cable T connector



CC6P

2 pin Cable T connector



RE-RGBW



CON-LED

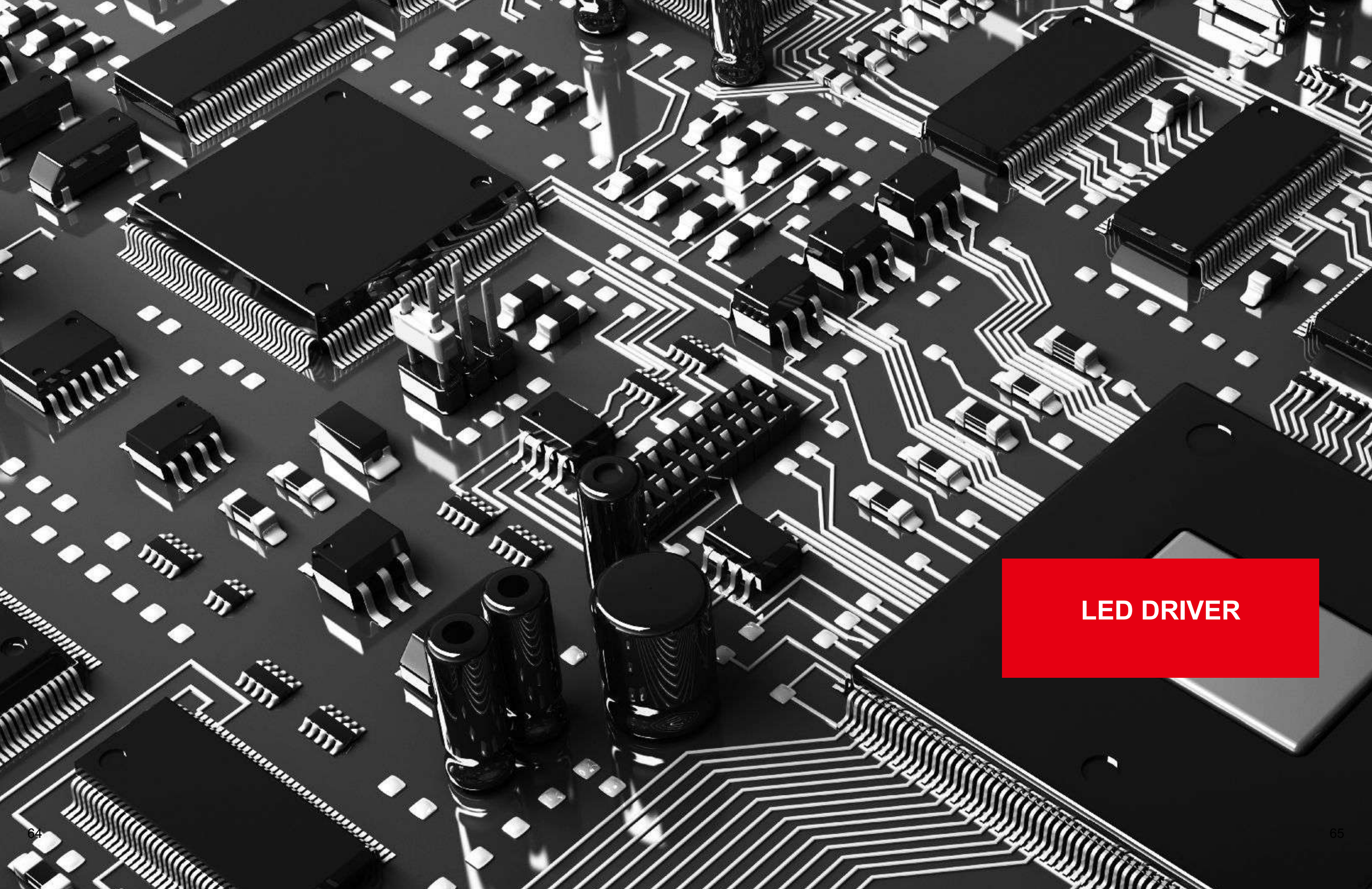

LED DRIVER

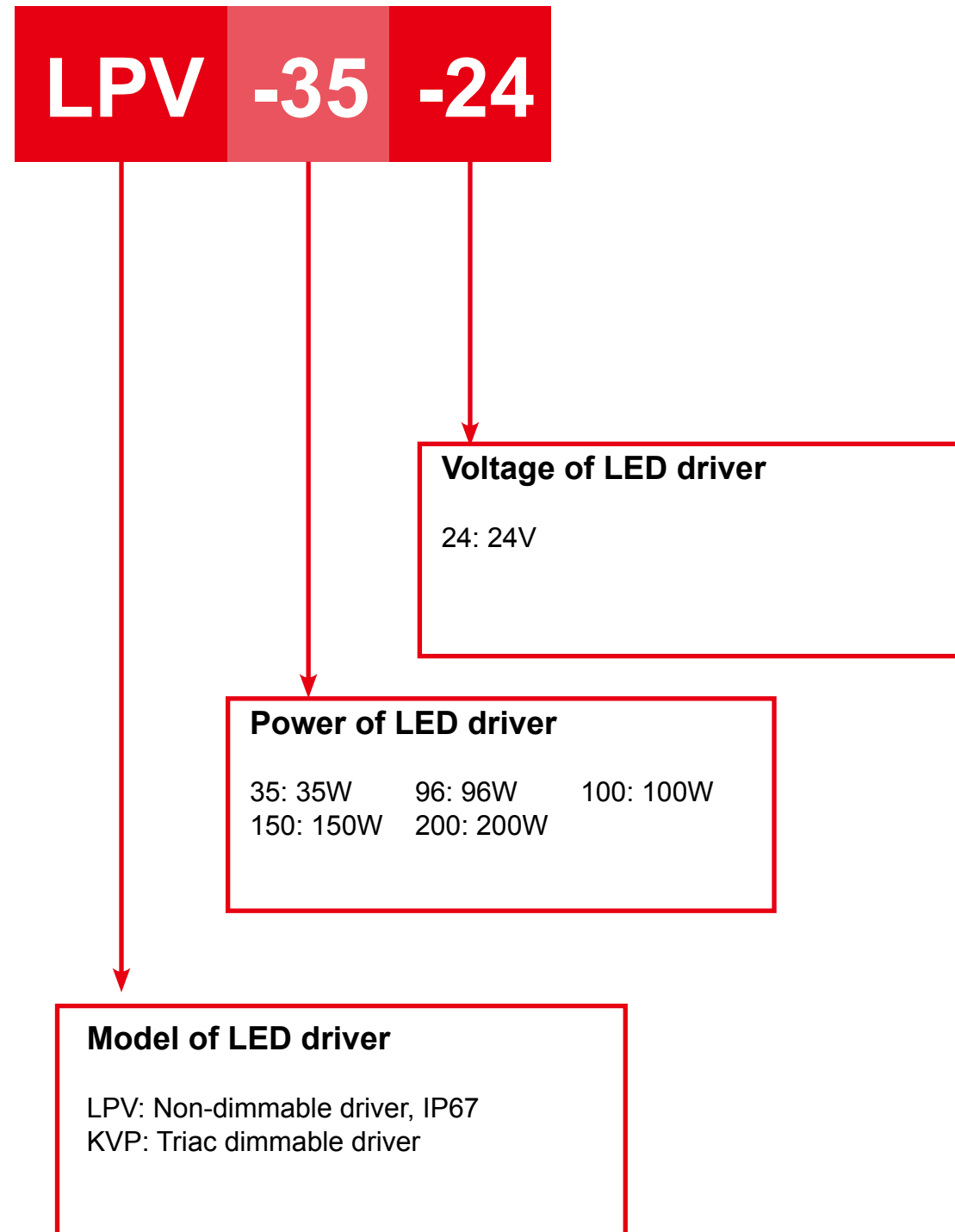

Non-dimmable Driver



LPV-35-24



LPV-60-24



LPV-100-24



LPVL-150-24

Triac Dimmable Driver



KVP-50-24



KVP-96-24



KVP-150-24



KVP-200-24



Non-Dimmable driver



LPV-35-24

Input voltage: 90~264 VAC
 Output voltage: 24V
 Power: 35 W
 Size: 148x40x30 MM
 Waterproof: IP67
 Efficiency: 85%

Tension d'entrée: 90~264 VAC
 Tension de sortie: 24V
 Puissance: 35 W
 Taille: 148x40x30 MM
 Étanche: IP67
 Efficacité: 85%



LPV-60-24

Input voltage: 90~264 VAC
 Output voltage: 24V
 Power: 60 W
 Size: 162.5x42.5x32 MM
 Waterproof: IP67
 Efficiency: 86%

Tension d'entrée: 90~264 VAC
 Tension de sortie: 24V
 Puissance: 60 W
 Taille: 162.5x42.5x32 MM
 Étanche: IP67
 Efficacité: 86%



LPV-100-24

Input voltage: 90~264 VAC
 Output voltage: 24V
 Power: 100 W
 Size: 190x52x37 MM
 Waterproof: IP67
 Efficiency: 88%

Tension d'entrée: 90~264 VAC
 Tension de sortie: 24V
 Puissance: 100 W
 Taille: 190x52x37 MM
 Étanche: IP67
 Efficacité: 88%



LPVL-150-24

Input voltage: 90~132 VAC
 Output voltage: 24V
 Power: 150 W
 Size: 190x63x37.5 MM
 Waterproof: IP67
 Efficiency: 89%

Tension d'entrée: 90~264 VAC
 Tension de sortie: 24V
 Puissance: 150 W
 Taille: 190x63x37.5 MM
 Étanche: IP67
 Efficacité: 89%

Dimmer List

Brand	Model Number*	Forward Phase or Reserve Phase	Dimming Range	Input Voltage Range
LUTRON	SCL-153PR-WH	Forward Phase	0 - 100%	100 - 130V
	DVCL-153PR-WH	Forward Phase	0 - 100%	100 - 130V
	DVWCL-153PH-LA	Forward Phase	0 - 100%	100 - 130V
LEVITON	TT106-1LZ	Forward Phase	1 - 100%	100 - 130V
	6602	Forward Phase	10 - 100%	100 - 130V
	6683	Forward Phase	12 - 100%	100 - 130V

*Contact us for more info

Triac Dimmable driver

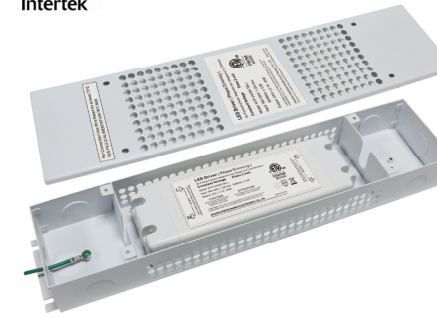

KVP-50-24-J1

Input voltage: 100~130 VAC
Output voltage: 24V
Power: 50 W
Driver size: 178x61x24 MM
With J1 Size: 350x77x37 MM
Waterproof: IP20
Efficiency: 84%

Tension d'entrée: 100~130 VAC
Tension de sortie: 24V
Puissance: 50 W
Taille: 178x61x24 MM
Avec J1 Taille: 350x77x37 MM
Étanche: IP20
Efficacité: 84%



KVP-96-24-J2

Input voltage: 100~130 VAC
Output voltage: 24V
Power: 96 W
Driver size: 230x70x46 MM
With J2 Size: 380x77x57 MM
Waterproof: IP66
Efficiency: 83%

Tension d'entrée: 100~130 VAC
Tension de sortie: 24V
Puissance: 96 W
Taille: 230x70x46 MM
Avec J2 Taille: 380x77x57 MM
Étanche: IP66
Efficacité: 83%



KVP-150-24-J3

Input voltage: 100~130 VAC
Output voltage: 24V
Power: 50 W
Driver size: 256x78x47 MM
With J3 Size: 406x87x60 MM
Waterproof: IP66
Efficiency: 86%

Tension d'entrée: 100~130 VAC
Tension de sortie: 24V
Puissance: 150 W
Taille: 256x78x47 MM
Avec J3 Taille: 406x87x60 MM
Étanche: IP66
Efficacité: 86%



KVP-200-24-J3

Input voltage: 100~130 VAC
Output voltage: 24V
Power: 200 W
Driver size: 256x78x47 MM
With J3 Size: 406x87x60 MM
Waterproof: IP66
Efficiency: 85%

Tension d'entrée: 100~130 VAC
Tension de sortie: 24V
Puissance: 200 W
Taille: 256x78x47 MM
Avec J1 Taille: 406x87x60 MM
Étanche: IP66
Efficacité: 85%

